

ACCESSIBLE PLAY AREAS

A Summary of Accessibility Guidelines for Play Areas



U.S. Access Board
Summary of Accessibility Guidelines
for Play Areas

The Americans with Disabilities Act (ADA) is a comprehensive civil rights law that prohibits discrimination on the basis of disability. The ADA requires that newly constructed and altered State and local government facilities, places of public accommodation, and commercial facilities be readily accessible to, and usable by, individuals with disabilities. Recreational facilities, including play areas, are among the facilities required to comply with the ADA.

The Architectural and Transportation Barriers Compliance Board - often referred to as the "Access Board" - has developed accessibility guidelines for newly constructed and altered play areas. The play area guidelines are a supplement to the Americans with Disabilities Act Accessibility Guidelines (ADAAG). Once these guidelines are adopted as enforceable standards by the Department of Justice, all newly constructed and altered play areas covered by the ADA will be required to comply. These guidelines also apply to play areas covered by the Architectural Barriers Act (ABA).

Summary

This guide is intended to help designers and operators in using the accessibility guidelines for play areas. These guidelines establish minimum accessibility requirements for newly constructed and altered play areas. This guide is not a collection of playground designs. Rather, it provides specifications for elements within a play area to create a general level of usability for children with disabilities. Emphasis is placed on ensuring that children with disabilities are generally able to access the diversity of components provided in a play area. Designers and operators are encouraged to exceed the guidelines where possible to provide increased accessibility and opportunities. Incorporating accessibility into the design of a play area should begin early in the planning process with consideration to layout, circulation paths, and the selection of play components.

The play area guidelines were developed with significant public input and carefully considered the balancing of costs, safety, and accessibility. The Access Board sponsored a Regulatory Negotiation Committee to develop proposed guidelines. The public was given an opportunity to comment on the proposed guidelines and the Access Board made changes to the proposed guidelines based on the public comments. The Regulatory Negotiation Committee represented the following groups and associations:

American Society of Landscape Architects	National Easter Seal Society
ASTM Public Playground Committee	National League of Cities
ASTM Soft Contained Play Committee	National Parent-Teacher Association
ASTM Playground Surfacing Systems Committee	National Recreation and Park Association
International Play Equipment Manufacturers Association	Spina Bifida Association of America
National Association of Counties	TASH
National Association of Elementary School Principals	United Cerebral Palsy Association
National Child Care Association	U.S. Access Board
National Council on Independent Living	

This guide is designed to assist in using the play area accessibility guidelines and is divided into the following sections:

- Where Do the Play Area Guidelines Apply?
- What is a Play Component?
- How Many Play Components Must Be on an Accessible Route?
- What Are the Requirements for Accessible Routes?
- What Other Accessibility Requirements Apply to Play Components?
- Soft Contained Play Structures

Copies of the play area accessibility guidelines and further technical assistance can be obtained from the U.S. Access Board, 1331 F Street, Suite 1000 NW, Washington, DC 20004-1111; 800-872-2253, 800-993-2822 (TTY); www.access-board.gov. Alternate formats of this document are also available upon request.

October 2005



Play Area Terms	4-5
<hr/>	
Where Do the Play Area Guidelines Apply?	6-8
<hr/>	
New Construction	6
Alterations.....	6
Equivalent Facilitation.....	6
Phasing in Play Areas	7
Play Areas Separated By Age.....	8
Geographically Separated Play Areas.....	8
What is a Play Component?	9-13
<hr/>	
Play Components.....	9
Different “Types”.....	10-11
Elevated Play Components.....	12
Ground-Level Play Components.....	13
How Many Play Components Must Be On An Accessible Route?	14-18
<hr/>	
Ground Level Play Components - One of Each Type.....	14
Ground Level Requirements - Based on Elevated Play Components ...	15
Elevated Play Components.....	16
Step-by-Step Guide	17
<hr/>	
Play Area Evaluation Example	18
<hr/>	
What Are the Requirements For Accessible Routes?	19-32
<hr/>	
Accessible Routes.....	19
Ground-Level Accessible Routes	20-21
Accessible Ground Surfaces.....	22
Accessible Surfaces Located in the Use Zone.....	22-23
Elevated Accessible Routes.....	24
When Ramps Are Required.....	25-27
When Transfer Systems Are Used.....	28-31
Connected Elevated Components.....	32
What Other Accessibility Requirements Apply to Play Components?	33-37
<hr/>	
Clear Floor or Ground Space.....	33
Maneuvering Space.....	34
Entry Points and Seats.....	35
Play Tables.....	36
Reach Ranges (Advisory).....	37
Soft Contained Play Structures	38
<hr/>	
Alterations	39
<hr/>	
Acknowledgements	40
<hr/>	

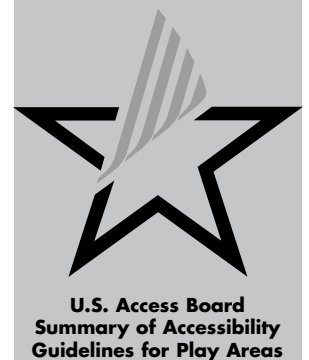

Play Area Terms

Many terms are used throughout this guide to describe the play area guidelines. Familiarity with these terms is important when applying the guidelines. Other definitions are provided in ADA/ABA.

ABA - Architectural Barriers Act

Access Board – An independent Federal agency that develops accessibility guidelines under the ADA and other laws. The Access Board is also known as the Architectural and Transportation Barriers Compliance Board.

Accessible – Describes a site, building, facility, or portion thereof that complies with the play area guidelines.

Accessible Route – A continuous unobstructed path connecting all accessible elements and spaces of a building or facility. Inside the boundary of the play area, accessible routes may include platforms, ramps, elevators, lifts. Outside the boundary of the play area, accessible routes may also include parking access aisles, curb ramps, crosswalks at vehicular ways, walks, ramps, and lifts.

ADA – Americans with Disabilities Act.

Alteration – An alteration is a change to a building or facility that affects or could affect the usability of the building or facility or part thereof. Alterations include, but are not limited to, remodeling, renovation, rehabilitation, reconstruction, historic restoration, resurfacing of circulation paths or vehicular ways, changes or rearrangement of structural parts or elements, and changes or rearrangement in the plan configuration of walls and full-height partitions. Normal maintenance is not an alteration unless it affects the usability of the facility (*see section on alterations for more details*).

Amusement Attraction – Any facility, or portion of a facility, located within an amusement park or theme park, that provides amusement without the use of an amusement device. Examples include, but are not limited to, fun houses, barrels, and other attractions without seats.

ASTM – American Society for Testing and Materials.

Berm – A sloped surface at ground level designed to ascend or descend in elevation.

Clear – Unobstructed.

Composite Play Structure – Two or more play structures attached or functionally linked, to create one integral unit that provides more than one play activity (*ASTM F 1487-01*).

Cross Slope – The slope that is perpendicular to the direction of travel (*see running slope*).

Elevated Play Component – A play component that is approached above or below grade and that is part of a composite play structure consisting of two or more play components attached or functionally linked to create an integrated unit providing more than one play activity.



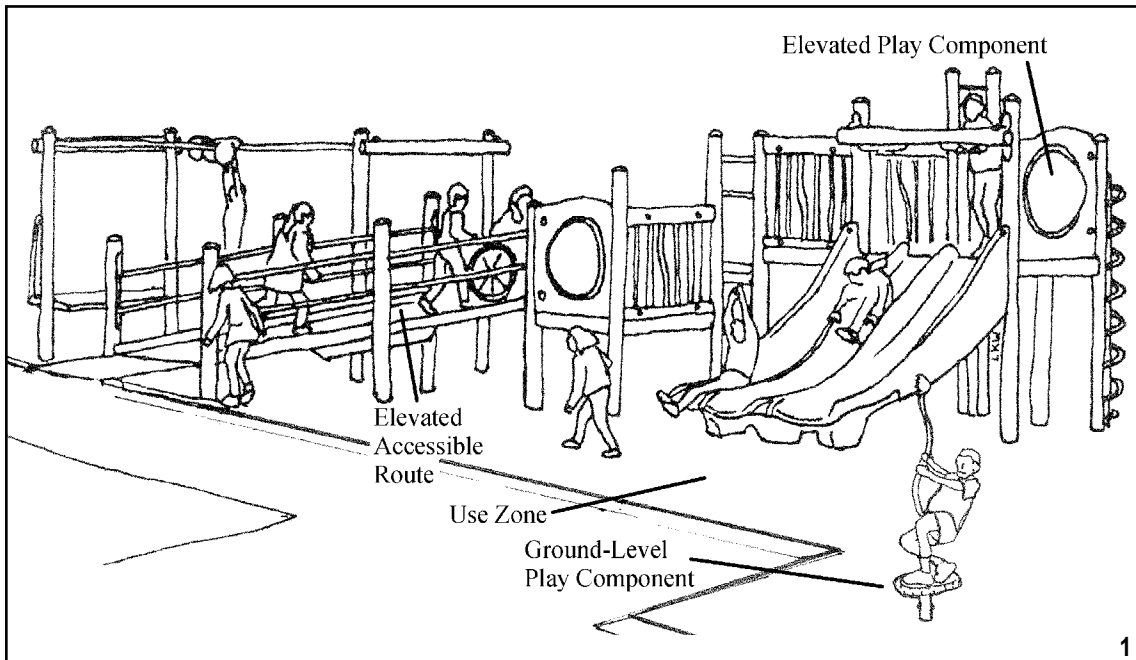

Facility – All or any portion of buildings, structures, site improvements, elements and pedestrian routes or vehicle ways located on a site.

Ground Level Play Component – A play component that is approached and exited at the ground level.

Play Area – A portion of a site containing play components designed and constructed for children.

Play Component – An element intended to generate specific opportunities for play, socialization, or learning. Play components may be manufactured or natural, and may be stand alone or part of a composite play structure.

Ramp – A walking surface that has a running slope of greater than 1:20.

Running Slope – The slope that is parallel to the direction of travel (*see cross slope*).

Site – A parcel of land bounded by a property line or a designated portion of a public right-of-way.

Soft Contained Play Structure – A play structure made up of one or more components where the user enters a fully enclosed play environment that utilizes pliable materials (e.g., plastic, netting, fabric).

Use Zone – The ground level area beneath and immediately adjacent to a play structure or piece of equipment that is designated by ASTM F 1487 Standard Consumer Safety Performance Specification for Playground Equipment for Public Use for unrestricted circulation. This is the play surface upon which it is predicted a user would land when falling from or exiting the equipment.



New Construction

The play area guidelines in this guide apply to all newly designed or constructed play areas for children ages 2 and older.

This includes play areas located in a variety of settings: parks, schools, childcare facilities, shopping centers, and public gathering areas. Owners or operators of newly constructed play areas are responsible for complying with these guidelines.

The play area guidelines do not apply to:

- Family childcare facilities where the proprietor resides
- Amusement attractions
- Religious entities



This large play area designed for the same age group is part of a public park system. The total of all the play components in this play area - which includes multiple composite structures - must be counted when applying the play area guidelines.

Alterations

The play area guidelines also apply to existing play areas where alterations occur. Further information regarding the application of the play area guidelines to altered play areas can be found on page 39.

Equivalent Facilitation

Designs that result in products or technologies as alternatives to those prescribed, provided substantially equivalent or greater accessibility and usability.

Equivalent facilitation is the concept of utilizing innovative solutions and new technology, design, or materials in order to satisfy the guidelines. These alternative solutions provide equal access and take advantage of new developments, but may differ technically from specific guidelines.

Phasing in Play Areas

When play areas are constructed in phases, they must continue to meet the play area guidelines throughout construction. The initial phase area must meet the guidelines, and then at each successive phase the whole play area must be reassessed to assure compliance.

“Phased designs” are play areas developed to be installed in different stages, allowing the play area to grow in a planned manner while accommodating budgets, fund raising, or community approval processes.

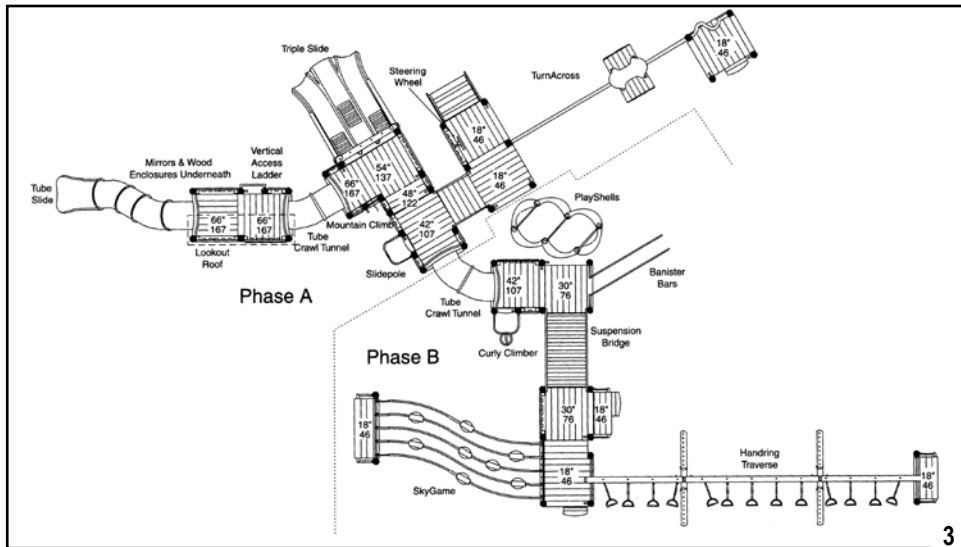

This play area will be installed in two phases. As each phase is completed, the entire play area must be reevaluated for compliance.

Prior to phase one, the first structure is evaluated for compliance, since the guidelines are based on a minimum number of play components required to be on an accessible route.

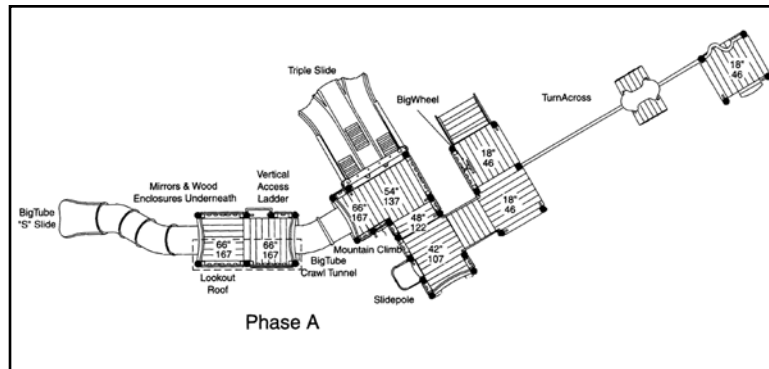

At the onset of phase two, the play area is reevaluated in its entirety.

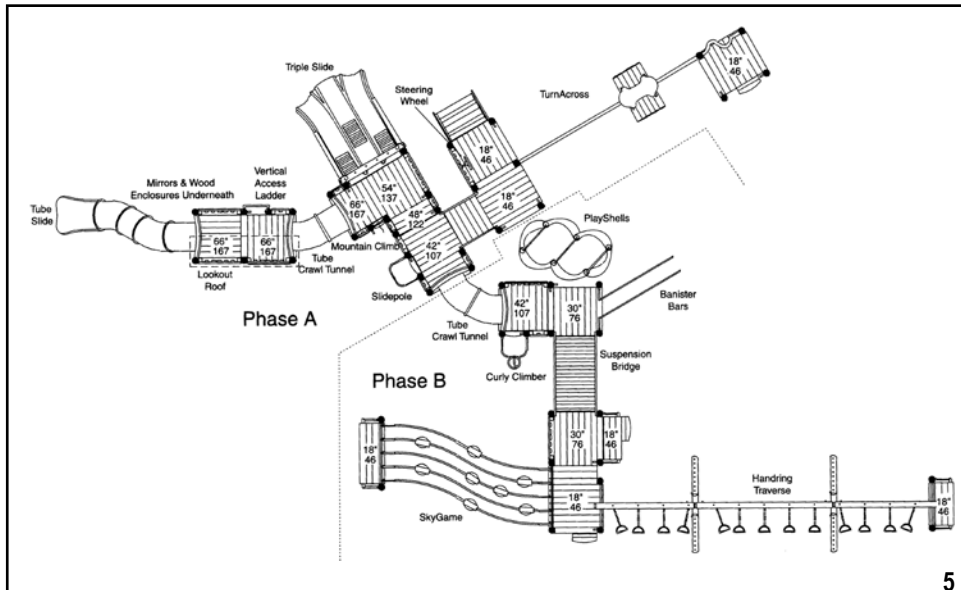

Play Areas Separated by Age

To reduce the risk of injury, safety guidelines recommend separate play areas for different age groups. In applying the guidelines, play areas designed for different age groups should be considered separately.

A play area designed for 2 to 5 year-olds is considered separate from one for 5 to 12 year-olds. Therefore, compliance with the guidelines must be considered for each individual play area.



This dual play area designed for 2 to 5 year-olds and 5 to 12 year-olds shares resilient surfacing. Each section must be evaluated separately.

Geographically Separated Play Areas

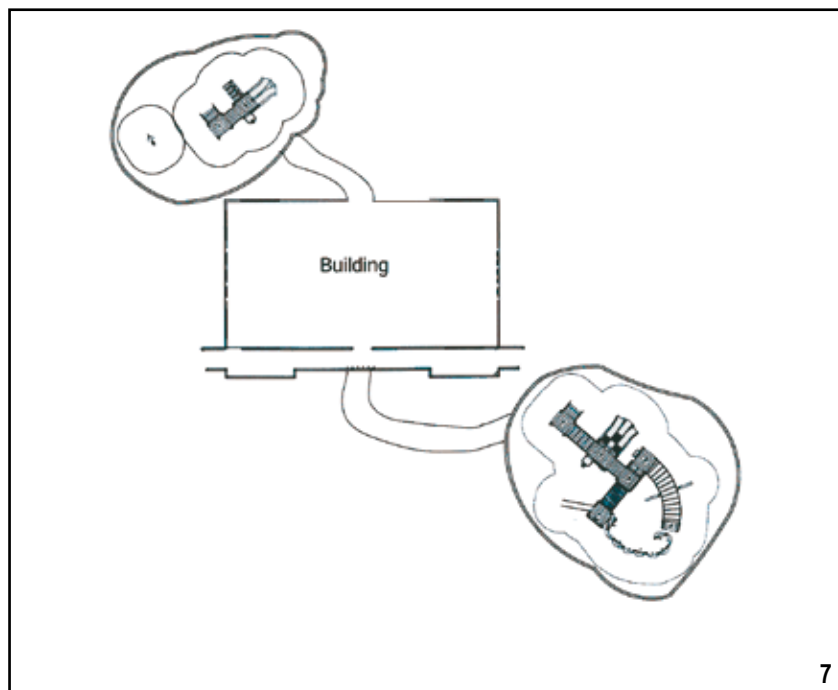

Large geographical spaces may contain several play areas within one park setting. Where play areas are geographically separated on a site, they are considered separate play areas. The accessibility guidelines apply to each play area.



Play Components

A play component is an element designed to generate specific opportunities for play, socialization, and learning. Play components may be manufactured or natural, and may be stand alone or part of a composite play structure. Swings, spring riders, water tables, playhouses, slides, and climbers are among the many different play components.

For the purpose of these guidelines, ramps, transfer systems, steps, decks, and roofs are not considered play components. These elements are generally used to link other elements on a composite play structure. Although socialization and pretend play can occur on these elements, they are not primarily intended for play.



Spring rider



Climber



Swing



Slide



WHERE DO THE PLAY AREA GUIDELINES APPLY?

When applying the play area guidelines, it is important to identify the different play experiences play components can provide.

Different “Types”

At least one of each type of play component provided at ground level in a play area must be on an accessible route.

Different “types” of play components are based on the general experience provided by the play component. Different types include, but are not limited to, experiences such as rocking, swinging, climbing, spinning, and sliding.

“Rocking” is an example of horizontal movement that can be backwards, forwards, sideways or even circular in nature.

“Sliding” is an example of rapid descent that utilizes the force of gravity.



A Swinging Type



A Rocking Type



This single play component provides one type of play experience for multiple individuals.



WHAT IS A PLAY COMPONENT?

The number of individuals who can play on a play component at once does not determine the quantity of play components provided in a play area. A play component can hold many children but is considered one type of play experience - or one play component - in the play area.



Examples of Sliding Types

While a spiral slide provides a slightly different experience from a straight slide, the primary experience - a sense of rapid descent or sliding - is common to both activities. Therefore, a spiral slide and a straight slide are considered one “type” of play experience.



WHAT IS A PLAY COMPONENT?

Elevated Play Components

An elevated play component is a play component that is approached above or below grade and is part of a composite play structure. Play components that are attached to a composite play structure and that can be approached from a platform or deck area are considered elevated play components.



This climber is considered an elevated component, since it can be approached or exited from the ground level or above grade from a platform or deck on a composite play structure.



Ground-Level Play Components

Ground-level play components are items that can be approached and exited at ground level. For example, a child approaches a spring rider at ground level via the accessible route. The child may ride then exit directly back onto the accessible route. The activity is considered ground level because the child approaches and exits it from the ground-level route.



Ground-level play components may be part of a composite structure.



Ground-level components may also be free-standing in a play area.

When more than one ground-level play component is required on an accessible route, the play components must be integrated. Designers should consider the optimal layout of ground-level play components to foster interaction and socialization among all children. Grouping all ground-level play components accessed by children with disabilities in one location does not constitute integration.

“Ground-level components” are approached and exited at ground level.

Ground-level play components may include items such as swings, spring riders, and panels.

Freestanding slides are considered ground-level components for the purpose of these guidelines. An accessible route must connect to the ladder or steps, and to the exit of the slide. While this solution does not provide access for all children, it gives many individuals the opportunity to access play components.



U.S. Access Board
Summary of Accessibility
Guidelines for Play Areas

Ground-Level Play Components

There are two requirements addressing how many ground-level play components must be on an accessible route:

- One of Each Type
- Ground-Level Requirements based on the number of Elevated Play Components

One of Each Type

At least one of each type of ground-level play component that is present in the play area must be on an accessible route.

As an example, this play area includes a composite play structure, two spring riders and a swing set (see inset). To meet the requirement, an accessible route must connect to at least one spring rider and one swing for one of each type of ground-level play experiences which are present in the play area.

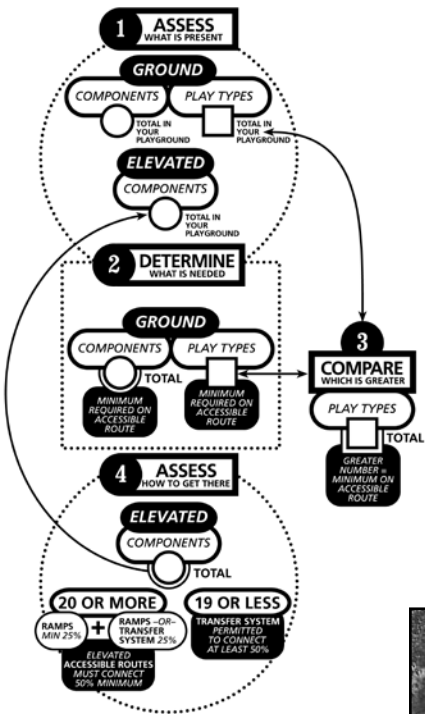

The above step-by-step guide is intended to assist when applying the play area guidelines. A detailed description is provided on page 17.

A “ground-level play component” is a play component that is approached and exited at the ground level.



HOW MANY PLAY COMPONENTS MUST BE ON AN ACCESSIBLE ROUTE?

Ground Level Requirements Based on Elevated Play Components

The number and variety of ground-level play components required to be on an accessible route is also determined by the number of elevated components provided in the play area.

The intent of this requirement is to provide a variety of experiences for individuals who choose to remain with their mobility aids, or choose not to transfer to elevated play components.

Number of elevated play components provided	Minimum number of ground-level play components required to be on accessible route	Minimum number of different types of ground-level play components required to be on accessible route
1	Not applicable	Not applicable
2 to 4	1	1
5 to 7	2	2
8 to 10	3	3
11 to 13	4	3
14 to 16	5	3
17 to 19	6	3
20 to 22	7	4
23 to 25	8	4
More than 25	8 plus 1 for each additional 3 over 25, or fraction thereof	5

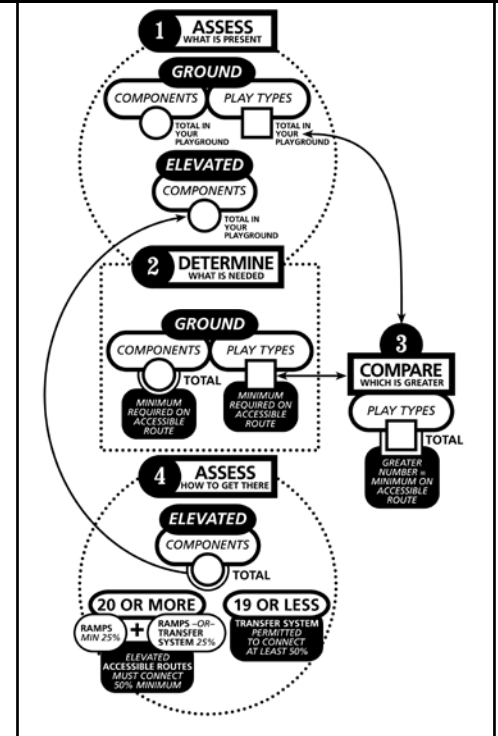

If ramps provide access to at least 50 percent of the elevated play components - which must include at least three different play types - then additional ground-level components are not required.

In the play area shown on page 14, the composite structure has four elevated play components (bubble panel, slide, steering wheel, and tic-tac-toe panel). According to the table, a minimum of one ground level play component must be provided, and a minimum of one different type. The spring rider or swing can be used to meet the “one of each type” requirement and can also be used to meet the minimum number determined by Table 240.2.1.2.



Elevated Play Components

At least 50 percent of the elevated play components must be on an accessible route.



Play areas with 20 or more elevated components must use ramps to connect a minimum of 25 percent of those components. A transfer system or ramps may connect the other elevated play components required on an accessible route.



Play areas with less than 20 elevated play components may use a transfer system instead of ramps to connect at least 50 percent of the elevated components.

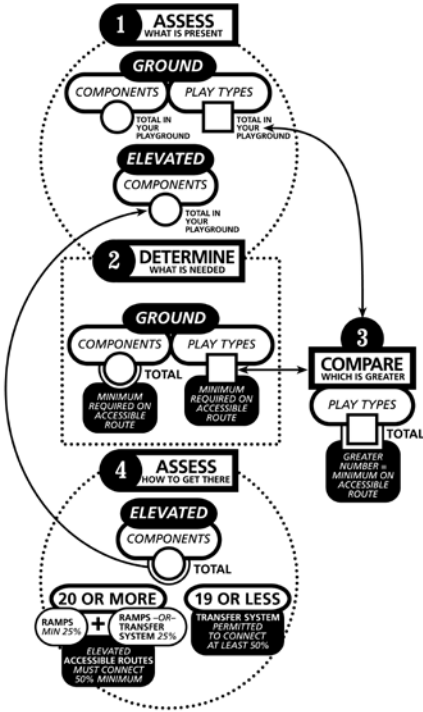

The above step-by-step guide is intended to assist when applying the play area guidelines. A detailed description is provided on page 17.

An “elevated play component” is a play component reached from above or below grade, and is part of a composite play structure.



U.S. Access Board
Summary of Accessibility
Guidelines for Play Areas

Step-by-Step Guide

The following step-by-step guide has been provided to assist in evaluating a play area for meeting the minimum requirements of these guidelines. The guide has been arranged in four steps and provides spaces to fill in numeric values of play components for evaluating a specific play area design.

The step-by-step guide is used throughout the remainder of this guide as a key, shown in the upper corner of each new section where it applies.

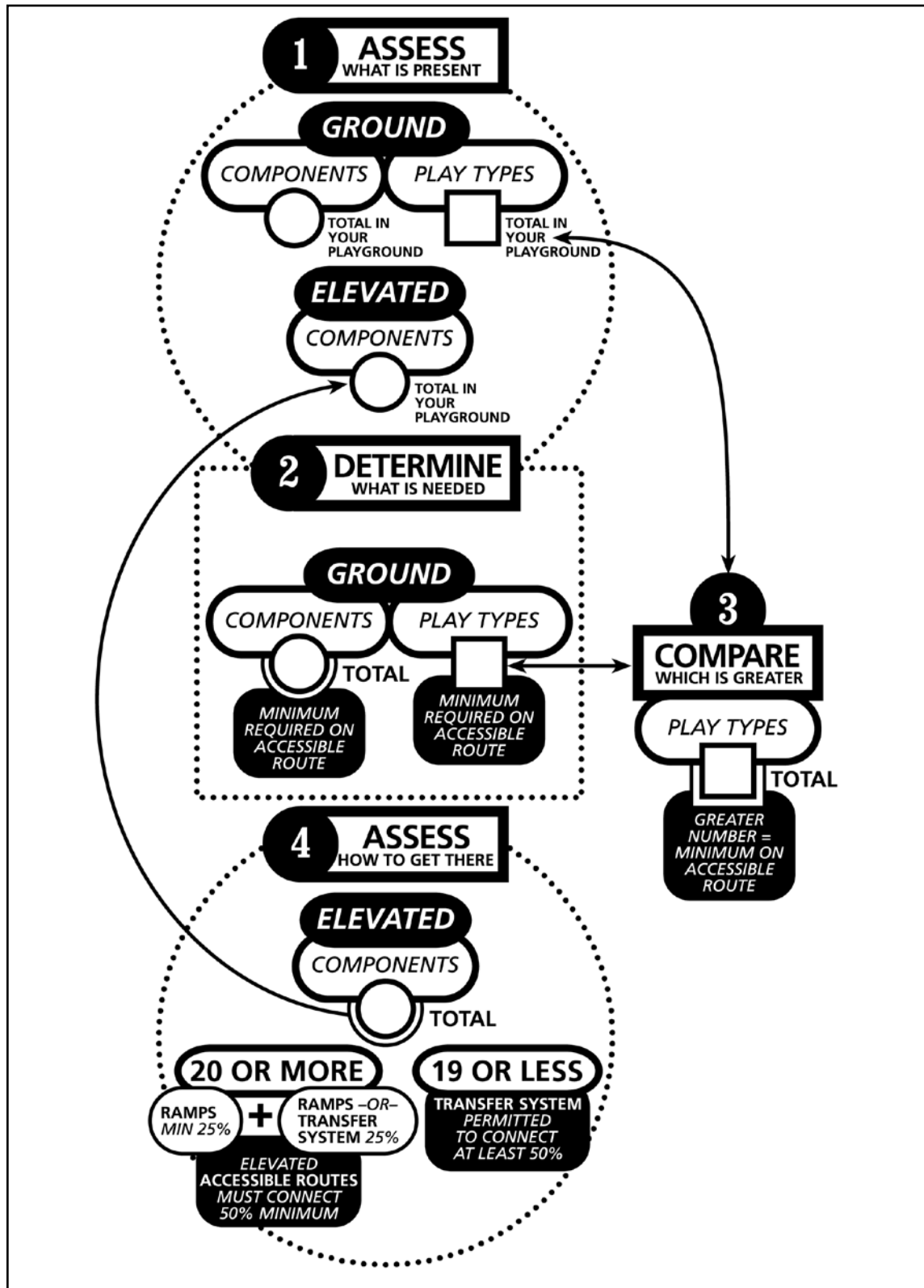

PLAY AREA EVALUATION EXAMPLE

The example below illustrates a proposed design for a new play area. Each section illustrated in the flow chart provides guidelines for the following design tasks:

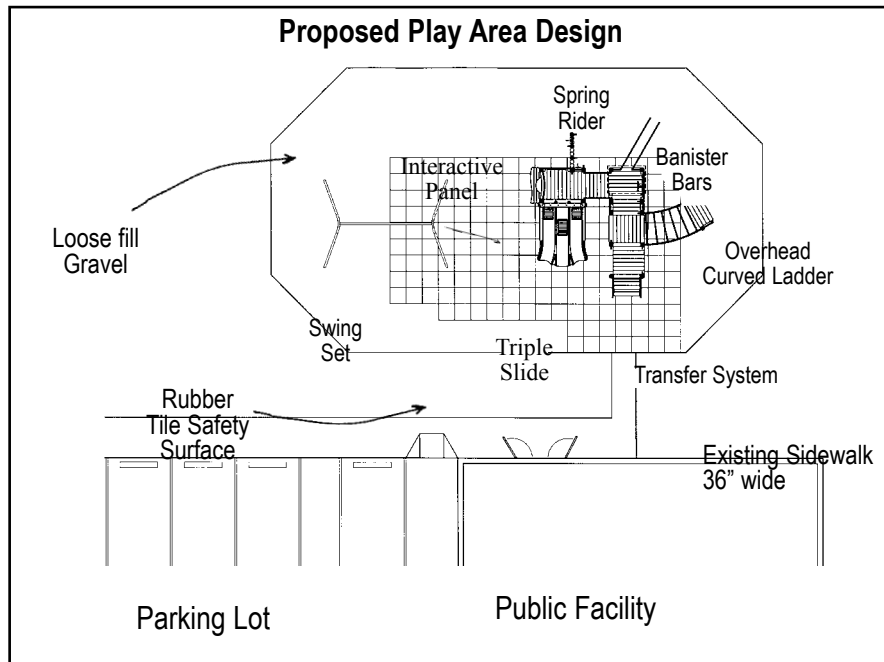

- Determining the number of play components
- Assessing the variety of play types
- Determining how many play components must be on an accessible route
- Determining when ramps are required and when transfer systems are permitted

Refer to this example while reviewing the concepts explained in this guide, to review how accessibility guidelines are applied to play area designs.

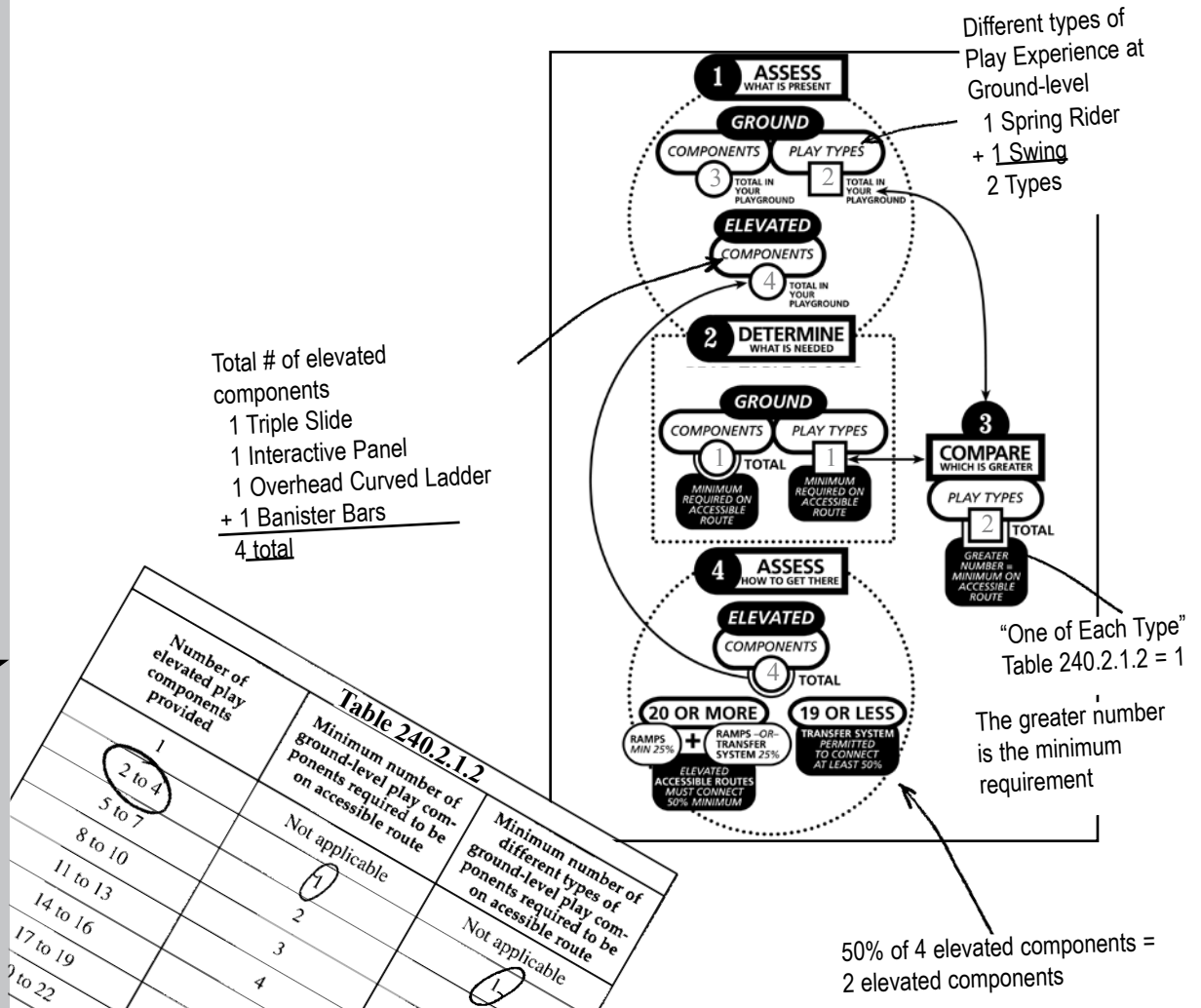

Table 240.2.1.2

Number of elevated play components provided	Minimum number of ground-level play components required to be on accessible route	Minimum number of different types of ground-level play components required to be on accessible route
1	2 to 4	1
5 to 7	Not applicable	2
8 to 10	1	3
11 to 13	2	4
14 to 16	3	Not applicable
17 to 19	4	Not applicable
20 to 22	Not applicable	1

WHAT ARE THE REQUIREMENTS FOR ACCESSIBLE ROUTES?

ADAAG chapter 4 addresses accessible routes that connect the play area to the school, parking lot, or facility that it serves. Operators or owners of play areas are subject to all the other requirements of the ADA, including the obligation to provide individuals with disabilities an equal opportunity to enjoy the play area provided by that facility.

This section describes the various features of accessible routes within a play area, including location, clear width, slope, and accessible surfaces.

Accessible Routes

An accessible route is a pathway specifically designed to provide access for individuals with disabilities, including those using wheelchairs or mobility devices.



Accessible routes inside the boundaries of play areas are addressed in the play area guidelines. Technical provisions address the width, slope, and surface of both ground-level and elevated accessible routes.

There are two types of accessible routes:

- Ground-level
- Elevated



This ground-level route connects ground components and the transfer system which connects elevated components.

This elevated route connects elevated play components on a composite structure.



The accessible route must connect all entry and exit points of accessible play components.

Clear floor space required at play components and maneuvering space can overlap the accessible route.

Incorporating additional circulation space around high-use play components creates extra room for movement and accessibility for everyone using the play area.



U.S. Access Board
A Summary of Accessibility
Guidelines for Play Areas

Ground-Level Accessible Routes

The 80-inch vertical clearance applies to ground-level routes only, and not elevated routes. This allows features like protective roofs and sun shelters to be present.

A ground-level accessible route connects play components at ground level.

- 60 inches (1525 mm) minimum clear width
- 1:16 maximum slope

The route may narrow down to 36 inches (915 mm) for a distance of 60 inches (1525 mm). This permits flexibility to work around site design features like existing equipment or trees.

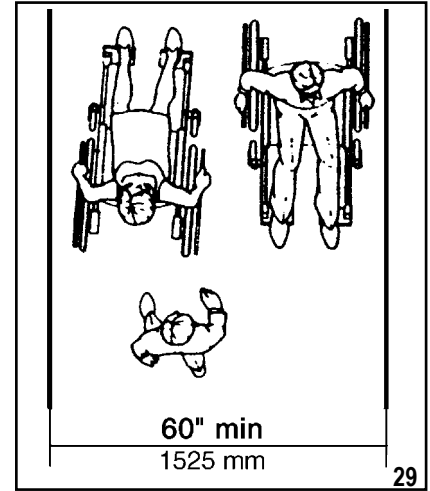
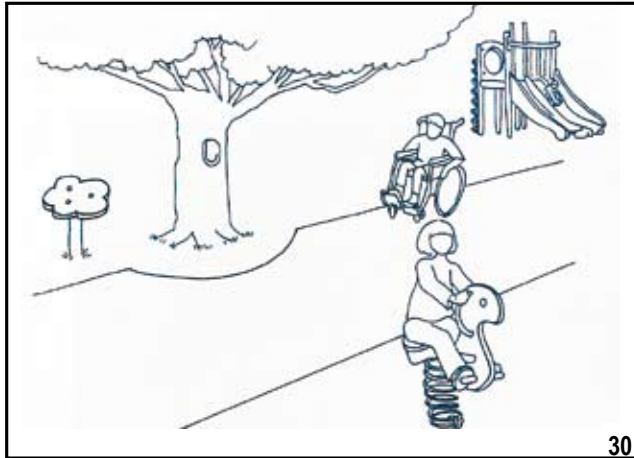

The required 60-inch width enables two wheelchairs to pass each other or to change direction.

Smaller play areas - those that are less than 1,000 square feet (93 square meters) - may have ground-level accessible routes that are 44 inches (1120 mm) clear width. A wheelchair turning space must be provided where the route exceeds 30 feet (9.14 mm) in length.

At ground level, objects may not protrude into the 60-inch wide space of an accessible route up to or below the height of 80 inches (2030 mm), measured above the accessible route surface. The 80-inch clearance applies only to the 60-inch accessible route, and is not required for the entire play area.

The play area provides a fun accessible roadway theme. The protective shelters for the benches have been set outside the boundary of the route providing the 80 inches of clearance required on the route.



WHAT ARE THE REQUIREMENTS FOR ACCESSIBLE ROUTES?

Ground-Level Accessible Routes

Maximum Slope at Ground Level

The maximum allowable slope for a ground-level accessible route is 1:16.

Berms are sometimes used to provide access to elevated play areas. A berm may be a natural sloped surface that is present in a hilly play area site, or a ground-level route built with slopes.

Designers are encouraged to consider edge protection and handrails on berms where there may be a drop-off. Remember the maximum slope of this “ground-level accessible route” is 1:16.

However, handrails are not required on ground-level accessible routes. This is permitted since the handrails may become a safety hazard in the “use zone.”



This play area provides a bermed accessible route.



To accommodate a height change along the perimeter of a play area - like these rubber safety tiles placed on an asphalt surface - an allowable 1:12 slope is utilized for the transition at the boundary of the play area.



U.S. Access Board
A Summary of Accessibility
Guidelines for Play Areas

Accessible Ground Surfaces

The “use zone” is a ground level area beneath and immediately adjacent to a play structure or piece of equipment that is designated for unrestricted circulation around the equipment. It is predicted that a user would fall and land or exit the equipment on the surface of the use zone.

The American Society for Testing and Materials (ASTM) has established safety standards for play areas, including resilient surfaces. For further information or to purchase these standards, contact ASTM, 100 Barr Harbor Drive, West Conshohocken, PA 19428-2959, www.astm.org.

Ground surfaces along accessible routes, clear floor or ground spaces, and maneuvering spaces, must comply with the American Society for Testing and Materials (ASTM) F 1951-99 *Standard Specification for Determination of Accessibility to Surface Systems Under and Around Playground Equipment*.

This standard assesses the accessibility of a surface by measuring the work an individual must exert to propel a wheelchair across the surface. The standard includes tests of effort for both straight-ahead and turning movements, using a force wheel on a rehabilitation wheelchair as the measuring device. To meet the standard, the force required must be less than that which is required to propel the wheelchair up a ramp with a slope of 1:14.

When selecting ground surfaces, operators should request information about compliance with the ASTM F 1292-04 standard.



Accessible surfaces can include impact-attenuating tiles made of recycled rubber and engineered wood fiber that meet the ASTM requirements for accessibility and safety. The design can be created so safety is not compromised for individuals using the play area where both standards are applied.

Accessible Surfaces Located In The Use Zone

If located within the use zone, accessible ground surfaces must also be impact attenuating and meet ASTM F 1292-04 *Standard Specification for Impact Attenuation of Surface Systems Under and Around Playground Equipment*.



U.S. Access Board
A Summary of Accessibility
Guidelines for Play Areas

WHAT ARE THE REQUIREMENTS FOR ACCESSIBLE ROUTES?



Accessible and non-accessible surfaces can be combined to provide variety and excitement in the play area.



At the time of this publication, rubber surfacing and some engineered wood fiber products meet the ASTM F 1951-99 standard. The fact that a specific product meets the ASTM 1951-99 standard does not necessarily mean that all other similar products will meet the standard.



Rubber surfacing tiles facilitate access in this play area.

Ground surfaces must be inspected and maintained regularly and frequently to ensure continued compliance with the ASTM F 1292-04 standard. The frequency of maintenance and inspection of resilient surfacing depends on the amount of use and the type of surfacing installed.

Operators interested in selecting surfaces to comply with the play area guidelines, should consult individual product manufacturers to determine compliance with ASTM F 1951-99.



Accessible surfacing can be designed to complement the theme of the play area, while providing full access and visually integrating the surface into the overall design. Individuals of all abilities will enjoy the added benefits of an imaginative design.

Engineered wood fiber surfaces will require frequent maintenance to comply with the ASTM F 1292-04 standard because of surface displacement due to user activity or other factors.

Designers and operators are likely to choose materials that best serve the needs of each play area. The type of material selected will affect the frequency and cost of maintenance.



U.S. Access Board
A Summary of Accessibility
Guidelines for Play Areas

Elevated Accessible Routes

“Ramps” serve as a continuation of the accessible route from the ground allowing individuals who use mobility devices to access elevated components. The guidelines require that play areas containing 20 or more elevated play components provide ramp access to at least 25 percent of those elevated components.

An elevated accessible route is the path used for connecting elevated play components.

Elevated accessible routes must connect the entry and exit points of at least 50 percent of the elevated play components provided in the play area.

Two common methods for providing access to elevated play components are ramps and transfer systems. Ramps are the preferred method since not all children who use wheelchairs or other mobility devices may be able to use - or may choose not to use - transfer systems.



This photo illustrates an elevated accessible route:

- 36-inch (915 mm) clear width
- 32-inch (815 mm) narrowed width permitted for 24-inch (610 mm) length to accommodate features in the composite structure
- 12-inch (305 mm) rise maximum per ramp run
- Top of handrail gripping surfaces shall be 20 inches (510 mm) minimum to 28 inches (710 mm) maximum above the ramp surface



The 80-inch vertical clearance height does not apply to elevated accessible routes. This allows for the use of features such as roofs and sun shelters.



WHAT ARE THE REQUIREMENTS FOR ACCESSIBLE ROUTES?

When Ramps Are Required

Ramps are required on composite structures with 20 or more elevated play components and must connect to at least 25% of the elevated play components.

Ramps allow individuals who use wheelchairs and mobility devices to access elevated play components in composite play structures without transferring.



This play area has more than 20 play components and provides ramp access to elevated play components. The ramp system, consisting of ramp runs and landings, must connect at least 25 percent of the elevated play components. The balance of the elevated play components required to be on an accessible route may be connected by the ramp system, or by a transfer system.

Rise of a ramp is the amount of vertical distance the inclined or slanted surface ascends or descends. A ramp **run** is a length of a continuous sloped surface that is ascending or descending. For example, to reach a 12-inch high deck or platform, a designer could use a 12-foot ramp with the maximum 1:12 slope, or a 14-foot ramp with a less steeper 1:14 slope.

Platform lifts, also known as “wheelchair lifts,” may be considered for providing access to elevated play components when appropriate.

Where applicable, platform lifts complying with ADA/ABA Accessibility Guidelines chapter 4 and applicable state and local codes are permitted as a part of an accessible route. Because lifts must be independently operable, owners and operators should carefully consider the appropriateness of their use in unsupervised settings.



U.S. Access Board
A Summary of Accessibility
Guidelines for Play Areas

“Ramps” are sloped surfaces that provide individuals who use mobility devices with access to elevated components.

Ramps

For each elevated ramp run:

- 12-inch (305 mm) maximum rise
- 1:12 maximum slope
- 36-inch (915 mm) minimum clear width



Landings

Landings are the level surfaces at the top and bottom of each ramp run.

- Must be as wide as the ramp they connect to
- A minimum length of 60-inches (1525 mm)
- If ramps change direction, the minimum landing size must be 60 inches (1525 mm) wide to accommodate a turn

Maneuvering Space Where Ramps are Provided

At least one maneuvering space must be provided on the same level as the play component. The space must have a slope no steeper than 1:48 in all directions (see page 34 for further details).

ADA/ABA Accessibility Guidelines addresses additional requirements for ramps and landings including edge protection, cross slope, surfaces, and outdoor conditions.



WHAT ARE THE REQUIREMENTS FOR ACCESSIBLE ROUTES?

Handrails

Handrails are required on both sides of ramps connecting elevated play components. Handrails must comply with the following:

- Clearance between handrail gripping surfaces and adjacent surfaces and shall not be 1 1/2 inches (38mm) minimum.
- Handrail gripping surfaces shall be continuous along their length and shall not be obstructed along their tops or sides. The bottoms of handrail gripping surfaces shall not be obstructed for more than 20 percent of their length. Where provided, horizontal projections shall occur 1 1/2 inches (38mm) minimum below the bottom of the handrail gripping surface.



In this case, additional handrails have been provided.

Handrails are required to comply with ADA/ABA 505. However, extensions on handrails in the play area are not required. This is to prevent children running into protruding rails in the play area.



**U.S. Access Board
A Summary of Accessibility
Guidelines for Play Areas**

When Transfer Systems Are Used

A “transfer system” is an alternative to a ramp system in play areas where there are less than 20 total elevated play components.

The transfer system must connect to the ground-level accessible route and provide access to at least 50 percent of the elevated play components.

A transfer system provides access to elevated play components within a composite system by connecting different levels with transfer platforms and steps.

A transfer system provides access to elevated play components without the use of a wheelchair or mobility device. At least 50% of the elevated play components can be connected by a transfer system in play areas with less than 20 elevated components. In play areas with 20 or more elevated play components, transfer systems may be used to connect up to 25% of the elevated play components and the rest of the elevated play components required to be on an accessible route must be connected by a ramp.



A transfer system typically consists of a transfer platform, transfer steps, and transfer supports.

Where a transfer system is provided, a combination of transfer platforms and transfer steps provide a continuous accessible route to elevated play components. A transfer system provides individuals the space necessary to physically transfer up or down in a composite play structure. Where provided, a 24-inch (610 mm) minimum width is necessary for individuals moving around a structure.



Playful features can be part of the transfer system, providing interactive experiences from both an elevated or ground level approach.

Consider the distance someone must travel to reach play components accessed by transfer systems. On page 31, the illustration shows a transfer system placed directly next to the slide. Access to this type of elevated play component has been carefully designed to minimize the distance someone must transfer to reach it.

WHAT ARE THE REQUIREMENTS FOR ACCESSIBLE ROUTES?

Transfer Platforms

A transfer platform is a platform or landing that an individual who uses a wheelchair or mobility device can use to lift or *transfer* onto the play structure and leave the wheelchair or mobility device behind at ground-level.



- 11 inches (280 mm) to 18 inches (455 mm) height of top surface
- Minimum 24 inches (610 mm) wide
- Minimum 14 inches (355 mm) deep
- Unobstructed side

Adding a transfer step that leads to the ground's surface increases access for children exiting components at the ground level.

Transfer steps in a play area are not required to satisfy the general ADAAG stair requirements.

Maneuvering space and clear space is not required on elevated structures or at elevated play components reached by a transfer system.

Clear floor or ground space - used for parking wheelchair or mobility devices (commonly called “wheelchair parking”) - is required at the transfer platform.

The 48-inch long side (1200 mm) of the “wheelchair parking” space must be parallel to the 24-inch (610 mm) side of the transfer platform.

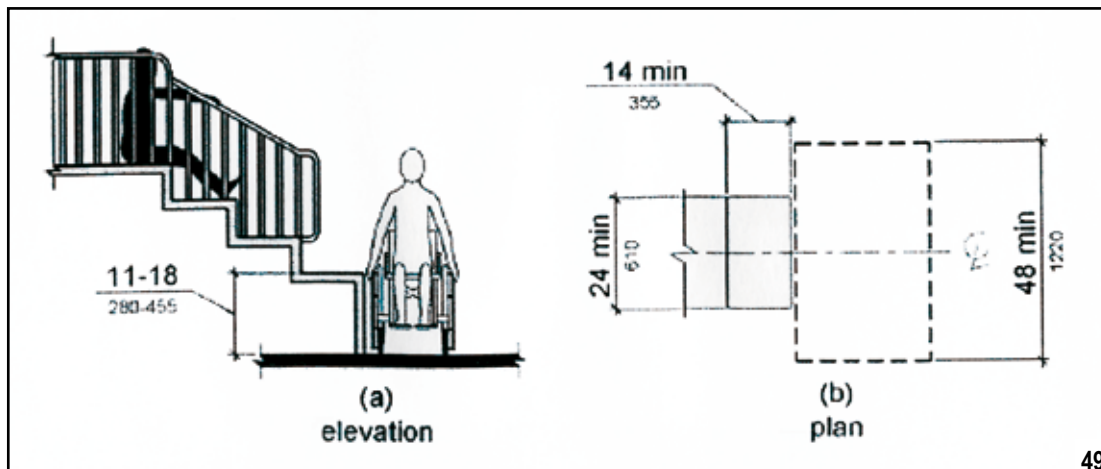

U.S. Access Board
A Summary of Accessibility
Guidelines for Play Areas

Transfer steps are level surfaces in a composite structure that can be used for transferring from different levels to access play components.

Transfer Steps

- Minimum 24 inches (610 mm) wide
- Minimum 14 inches (355 mm) deep
- 8 inches (205 mm) maximum height

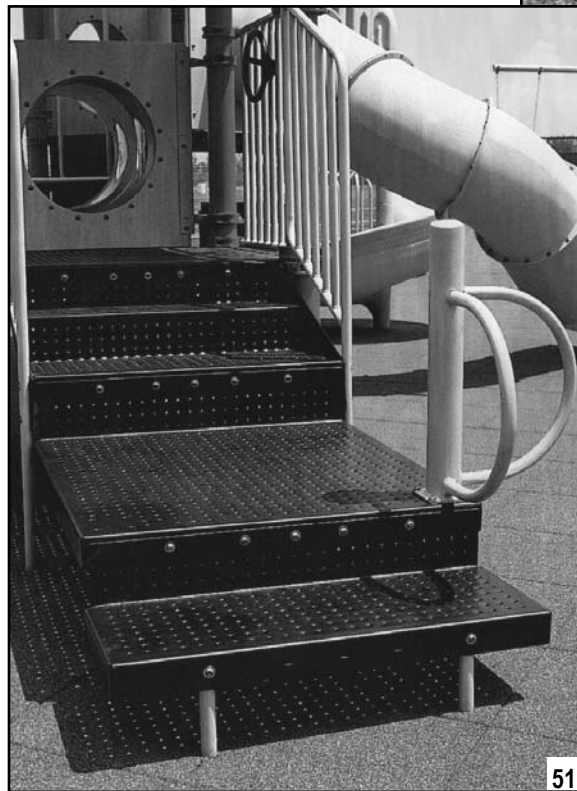

Play areas intended for smaller children should provide steps at smaller height increments. This will accommodate smaller sized children who must lift or “bump” up each step.



WHAT ARE THE REQUIREMENTS FOR ACCESSIBLE ROUTES?

Transfer Supports

Transfer supports must be provided on transfer platforms and transfer steps at each level where transferring is the intended method of access.

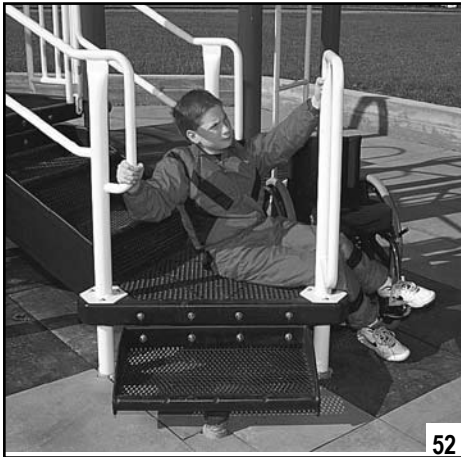

Materials in a variety of different shapes and sizes are used to manufacture transfer supports including metal, plastic, and rope.

A means of support is required when transferring into the entry or seat of a play component.

Transfer supports assist individuals with transferring and general mobility. They include handrails, handgrips, or custom designed handholds.

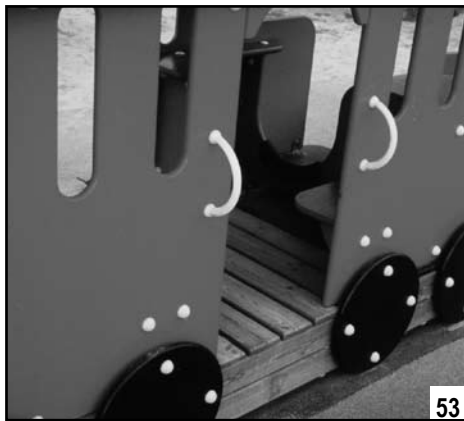

Aesthetically pleasing cut-out shapes and other design enhancements can provide hand supports for transferring.

Consideration must be given to the distance between the transfer system and the elevated play components it is intended to facilitate. Designers should minimize the distance between the point where a child transfers from a wheelchair or mobility device and the elevated play destination.

This transfer system provides access to exciting elevated play experiences like sliding while minimizing the distance individuals must traverse.

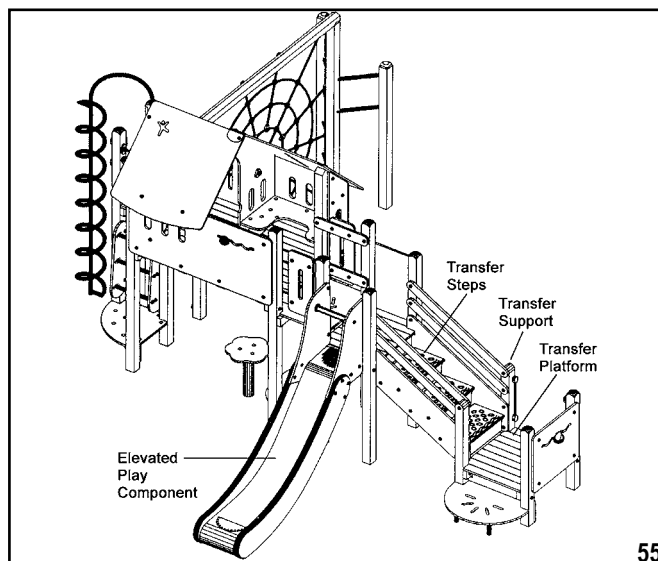

U.S. Access Board
A Summary of Accessibility
Guidelines for Play Areas

Connected Elevated Components

Elevated play components that are connected to other play components count toward fulfilling the requirement for the number of elevated components on an accessible route where transfer systems are used.

When transfer systems are used, an elevated play component may connect to other elevated play components, providing an innovative, accessible route.

A crawl tube is an elevated play component in this composite structure. Going through the tunnel provides access to additional activities on the other side.



Consideration should be given to how a play component is utilized when it is selected to connect to other elevated play events. When a transfer system is provided, children move through a play component like this crawling tube, using their own strength without a mobility device.



Providing variety and excitement through elevated play spaces benefits all children. Tunnels and tubes make “getting there” an activity in itself.



WHAT OTHER ACCESSIBILITY REQUIREMENTS APPLY TO PLAY COMPONENTS?

The play area guidelines address accessible routes connecting play components along with certain spaces that are crucial to making a play area usable for children with disabilities. The other requirements for play components are provided to promote general usability, with application to a variety of play components. Additional features will assist in making play components more accessible to more children. Designers are encouraged to consider components with back support, increased space for maneuvering adjacent to the play component, and other features that promote independent use.

Clear Floor or Ground Space

Clear floor space - also known as ground space - provides unobstructed room to accommodate a single stationary wheelchair and its occupant at a play component on an accessible route.

- 30-inch (760 mm) by 48-inch (1220 mm) minimum area
- May overlap accessible routes and maneuvering spaces
- Slope not steeper than 1:48 in all directions



The clear floor space is permitted to overlap onto the landing area to provide access to this elevated window activity.

Play components come in a variety of shapes and sizes facilitating a broad range of experiences. A specific location for clear floor or ground space has not been designated. Each play component is unique and the spaces must be placed in the best location for the situation.

This interactive play component has a clear ground space that allows front or side reach interaction.



Elevated play components accessed by transfer systems do not require maneuvering or clear floor spaces, since mobility devices are left at ground level.

Clear floor or ground space is also sometimes called "wheelchair parking space."

The minimum clear floor or ground space on a composite structure may be positioned for a forward or parallel approach. It may overlap accessible routes and maneuvering spaces.



U.S. Access Board
A Summary of Accessibility
Guidelines for Play Areas

Maneuvering Space

Maneuvering space is defined as the space required for a wheelchair to make a 180-degree turn. At least one maneuvering space must be provided on the same level as elevated play components.

When providing access to ground level and elevated play components by ramps, space allowances to accommodate wheelchairs and mobility devices are required.

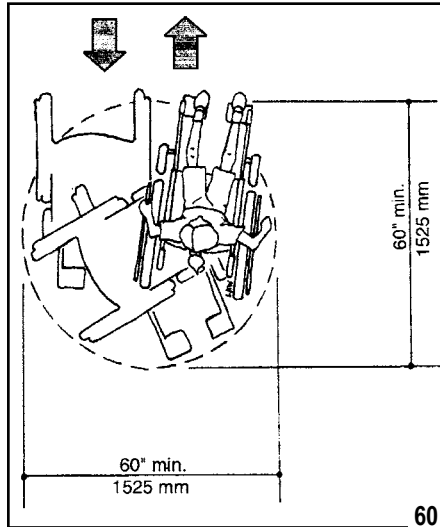

- A 60-inch (1525 mm) turning circle permits individuals with mobility devices to turn around
- A 60-inch (1525 mm) T-Shaped turn allows an individual to change directions by making a series of multi-point turns
- Slope not steeper than 1:48 in all directions

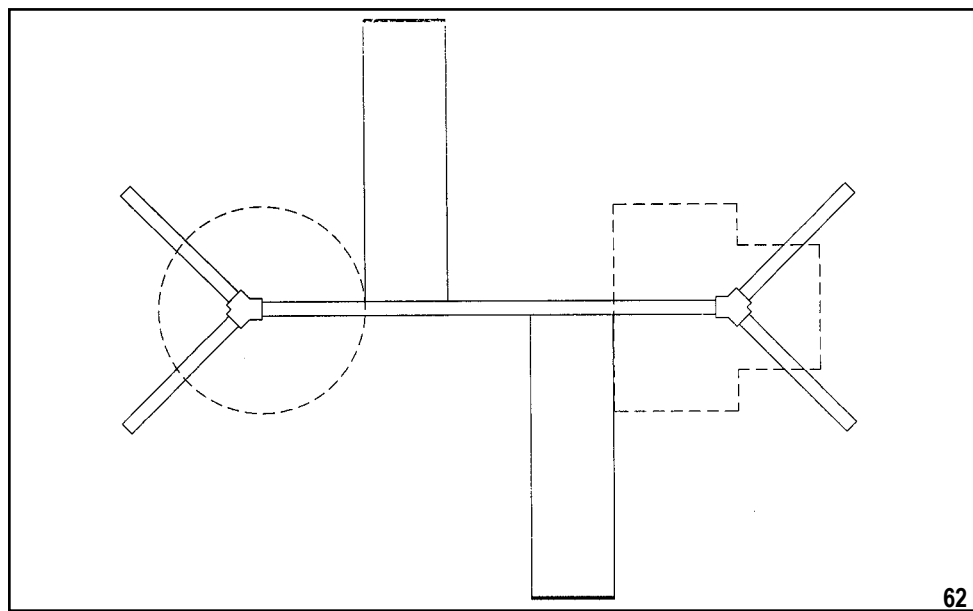

Maneuvering space is required for swings and must be located adjacent to the swing. This illustration shows options for either a 60-inch turning circle or a T-shaped turn. While this illustration shows the maneuvering space to the side of the swing, the space may be located behind or in front of the swing as long as it is immediately adjacent to the swing.

Objects are not permitted to protrude into ground level maneuvering spaces at or below 80 inches (2030 mm) above the ground or floor surface.



Entry Points and Seats

Entry points and seats are features of play components where individuals would transfer, sit, or gain access. When play components are located on an accessible route, the height required to transfer directly to the entry point or seat of a play component has a minimum of 11 inches (280 mm) and a maximum of 24 inches (610 mm). A mid-level height of 18 inches (455 mm) is recommended.



Examples of entry points and seats include swing seats, spring rocker seats, and crawl-tube openings.



Consider design features like open sides, back supports, and hand supports to help facilitate easy transfer and access.

The height of the entry point of a slide is not specified.



**U.S. Access Board
A Summary of Accessibility
Guidelines for Play Areas**

Play Tables

Play tables may be located at a ground or elevated level in a composite play structure. Consider the route, clear floor space and maneuvering spaces for tables intended to be accessible to individuals who use wheelchairs.

Play tables are surfaces, boards, slabs, or counters that are created for play. This includes tables designed for sand and water play, gathering areas, and other activities. Where play tables are located on an accessible route, the wheelchair knee clearance minimums are:

- 24 inches (610 mm) high minimum
- 30 inches (760 mm) wide minimum
- 17 inches (430 mm) deep minimum



Play tables designed primarily for children under 5-years-old, may provide a parallel approach instead of knee clearance if the rim is a maximum of 31 inches (785 mm) high.

The edge of this elevated sand table has been designed to provide access by providing a generous opening. The tops of rims, curbs, or other obstructions that would prevent access to a table surface should be 31 inches (785 mm) maximum in height.



Reach Ranges (Advisory)

The play area guidelines include advisory information on recommended reach ranges.

Reach ranges are the recommended designated regions of space that a person seated in a wheelchair can reasonably extend their arm or hand to touch, manipulate, move, or interact with an object or play component.

Reach ranges should be considered when providing play components with manipulative or interactive features for children who use wheelchairs. Recommended forward or side reach ranges are:

- 20 to 36 inches for 3 to 4 year-olds
- 18 to 40 inches for 5 to 8 year-olds
- 16 to 44 inches for 9 to 12 year-olds

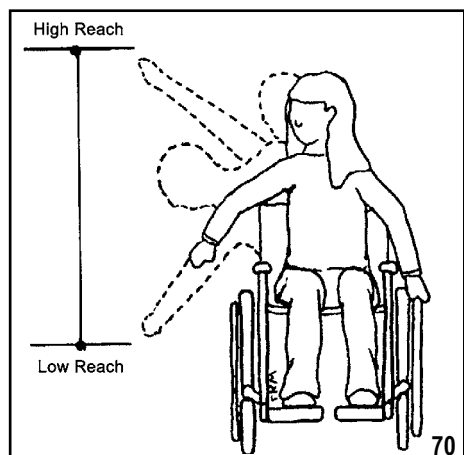

Side Reach

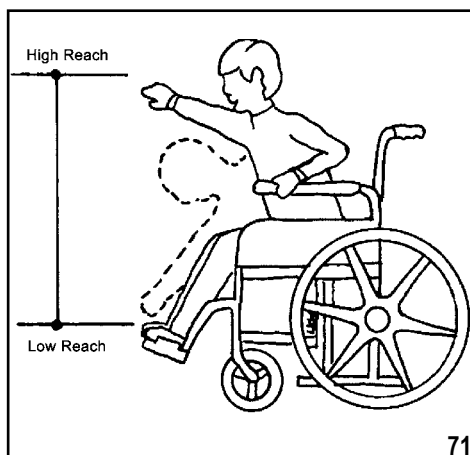

Forward Reach

The reach ranges appropriate for use by children who use wheelchairs to access play components are intended for ground-level components, and elevated components accessed by ramps. Reach ranges are not appropriate for play components reached by transfer systems.



Appropriate reach range heights will vary depending on how the play component is accessed. This interactive panel is mounted at a height appropriate for a child who uses a wheelchair.

The reach ranges in this guide are recommendations that should be considered when designing play components with manipulative features intended for use by individuals who use wheelchairs.



U.S. Access Board
A Summary of Accessibility
Guidelines for Play Areas

SOFT CONTAINED PLAY STRUCTURES

“Soft contained play equipment” is a play structure made of one or more components, on which an individual enters a fully enclosed play environment that uses pliable materials such as plastic, soft padding, and fabric.

Soft contained play structures must provide at least one entry point on an accessible route when three or fewer entry points are provided.

If four or more entry points are provided, at least two entry points must be located on an accessible route.

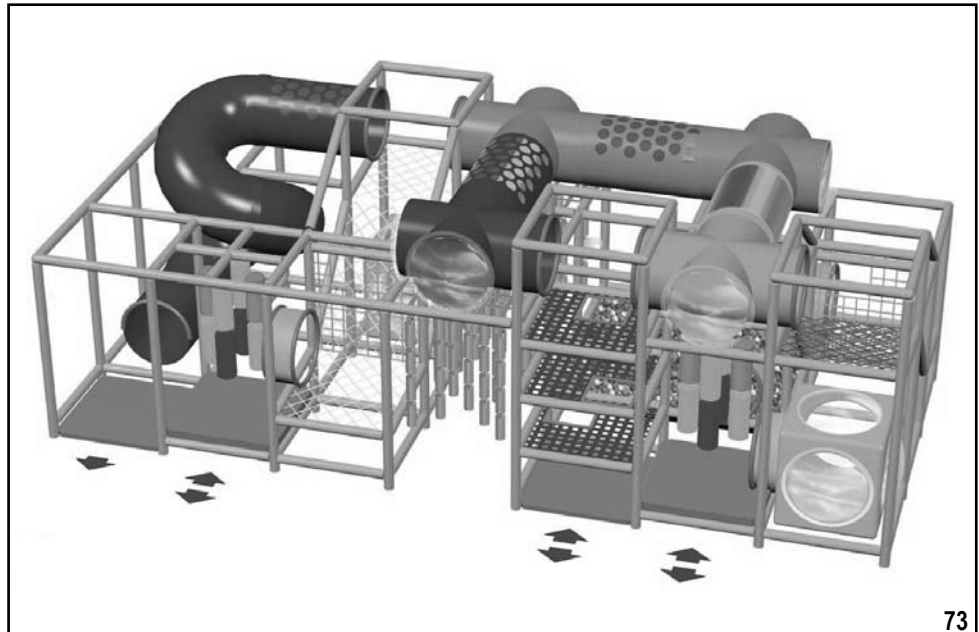

Soft contained play environments typically have limited entrance and exit locations, with play components integrated into the system design.



Transfer systems or platform lifts can serve as a part of an accessible route connecting entry points on soft-contained play structures.



U.S. Access Board
A Summary of Accessibility
Guidelines for Play Areas

The play area guidelines apply to alterations made to existing play areas that affect, or could affect, the usability of the play area. Examples include removing a climbing play component and replacing it with a spring rocker, or changing the ground surfacing.

Alterations provide an opportunity to improve access to existing play areas. Where play components are altered and the ground surface is not, the ground surface does not have to comply with the ASTM F 1951-99 standard for accessible surfaces unless the cost of providing an accessible surface is less than 20 percent of the cost of the alterations to the play components.

If the entire ground surface of an existing play area is replaced, the new ground surface must provide an accessible route to connect the required number and types of play components. The requirements for accessible routes are explained on page 19.



This play area was altered by adding two spring rockers. The seat of at least one spring rocker is between 11 inches (280mm) and 24 inches (610mm) maximum, and clear floor or ground space and maneuvering space is provided. If the ground surface is replaced in the future, an accessible route would have to be provided to the spring rocker.

Normal maintenance activities such as replacing worn ropes or topping off ground surfaces are not considered alterations.

If play components are relocated in an existing play area to create safe use zones, the guidelines do not apply, provided that the ground surface is not changed or extended for more than one use zone.

Replacing the entire ground surface does not require the addition of more play components.



U.S. Access Board
A Summary of Accessibility
Guidelines for Play Areas

ACKNOWLEDGEMENTS

The Access Board would like to thank the following manufacturers for their generous assistance and for supplying appropriate photographs or illustrations: Bob Leathers, Columbia Cascade, GameTime, KOMPAN, Landscape Structures, Little Tikes, Miracle, Olympic Recreation, Playworld Systems, and Recreation Creations.

The numerical listing below shows the source of each photo or illustration.

Top Cover Photo - KOMPAN	38. KOMPAN
Bottom Cover Photo - Miracle	39. KOMPAN
1. KOMPAN	40. GameTime
2. Little Tikes	41. GameTime
3. KOMPAN	42. GameTime
4. KOMPAN	43. Playworld Systems
5. KOMPAN	44. Landscape Structures
6. Little Tikes	45. Miracle
7. KOMPAN	46. Landscape Structures
8. Little Tikes	47. Little Tikes
9. KOMPAN	48. Landscape Structures
10. KOMPAN	49. KOMPAN
11. Landscape Structures	50. Game Time
12. Miracle	51. Recreation Creations
13. KOMPAN	52. Miracle
14. Little Tikes	53. KOMPAN
15. GameTime	54. Playworld Systems
16. Playworld Systems	55. KOMPAN
17. GameTime	56. KOMPAN
18. Little Tikes	57. KOMPAN
19. Landscape Structures	58. Olympic Recreation
20. Miracle	59. Playworld Systems
21. Recreation Creations	60. KOMPAN
22. Miracle	61. KOMPAN
23. Miracle	62. Access Board
24. Landscape Structures	63. Playworld Systems
25. Miracle	64. Little Tikes
26. Columbia Cascade	65. Landscape Structures
27. Playworld Systems	66. GameTime
28. GameTime	67. Playworld Systems
29. KOMPAN	68. Landscape Structures
30. Elizabeth Garufi	69. Bob Leathers
31. Little Tikes	70. KOMPAN
32. Playworld Systems	71. KOMPAN
33. KOMPAN	72. Miracle
34. Columbia Cascade	73. GameTime
35. KOMPAN	74. Access Board
36. KOMPAN	75. Miracle
37. Little Tikes	

